

规范书写

英语字母描红

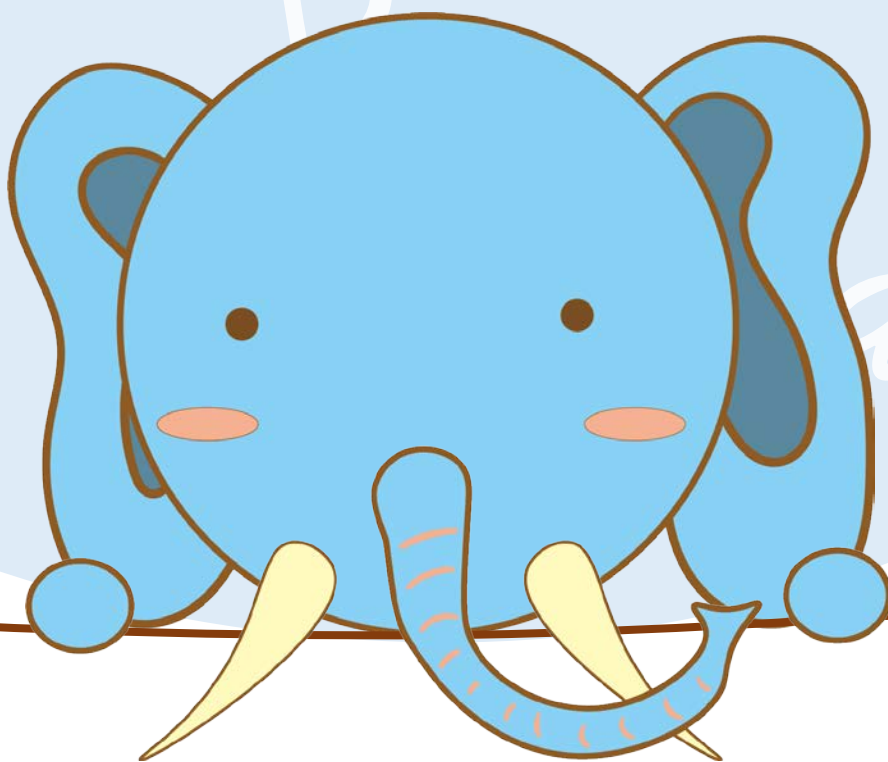

英语字母描红

班级_____

姓名_____



[eɪ]
Aa



apple
['æpl] 苹果

Aa Aa Aa Aa Aa Aa Aa

Aa Aa Aa Aa Aa Aa Aa

Aa Aa Aa Aa Aa Aa Aa

Aa Aa Aa Aa Aa Aa Aa

Aa

Aa



[bi:]
Bb



bird
[bɜ:d] 小鸟



Bb Bb Bb Bb Bb Bb Bb

Bb Bb Bb Bb Bb Bb Bb

Bb Bb Bb Bb Bb Bb Bb

Bb Bb Bb Bb Bb Bb Bb

Bb

Bb



[si:]
Cc



cat
[cæt] 猫

Cc Cc Cc Cc Cc Cc Dd

Cc Cc Cc Cc Cc Cc Cc

Cc Cc Cc Cc Cc Cc Cc

Cc Cc Cc Cc Cc Cc Cc

Cc

Cc



[di:]
Dd



dog
[dɒg] 狗



Dd Dd Dd Dd Dd Dd Dd

Dd Dd Dd Dd Dd Dd Dd

Dd Dd Dd Dd Dd Dd Dd

Dd Dd Dd Dd Dd Dd Dd

Dd

Dd



[i:]
Ee

egg
[eg] 鸡蛋

1 2 3

Ee Ee Ee Ee Ee Ee Ee

Ee Ee Ee Ee Ee Ee Ee

Ee Ee Ee Ee Ee Ee Ee

Ee Ee Ee Ee Ee Ee Ee

Ee

Ee



[ef]

Ff



fish

[fɪʃ] 鱼

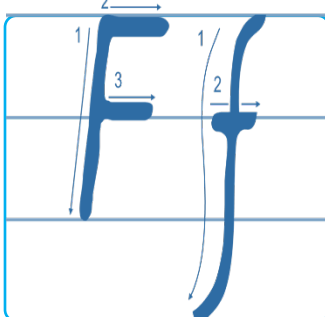

Ff Ff Ff Ff Ff Ff Ff

Ff Ff Ff Ff Ff Ff Ff

Ff Ff Ff Ff Ff Ff Ff

Ff Ff Ff Ff Ff Ff Ff

Ff

Ff



[dʒi:]
Gg



girl
[gɜ:l] 女孩

Gg Gg Gg Gg Gg Gg Gg

Gg Gg Gg Gg Gg Gg Gg

Gg Gg Gg Gg Gg Gg Gg

Gg Gg Gg Gg Gg Gg Gg

Gg

Gg



[eɪtʃ]

Hh



horse

[hɔ:s] 马

Hh Hh Hh Hh Hh Hh Hh

Hh Hh Hh Hh Hh Hh Hh

Hh Hh Hh Hh Hh Hh Hh

Hh Hh Hh Hh Hh Hh Hh

Hh

Hh



[ɑɪ]
Ii



ink
[ɪŋk] 墨水

Ii Ii Ii Ii Ii Ii Ii

Ii Ii Ii Ii Ii Ii Ii

Ii Ii Ii Ii Ii Ii Ii

Ii Ii Ii Ii Ii Ii Ii

Ii

Ii



[dʒeɪ]

Jj



juice

[dʒuːs] 果汁



Jj Jj Jj Jj Jj Jj Jj

Jj Jj Jj Jj Jj Jj Jj

Jj Jj Jj Jj Jj Jj Jj

Jj Jj Jj Jj Jj Jj Jj

Jj

Jj



[keɪ]
Kk



kite
[kaɪt] 风筝



Kk Kk Kk Kk Kk Kk Kk

Kk Kk Kk Kk Kk Kk Kk

Kk Kk Kk Kk Kk Kk Kk

Kk Kk Kk Kk Kk Kk Kk

Kk

Kk



[eɪ]

L l



lion

['laɪən] 狮子

L l L l L l L l L l L l L l

L l L l L l L l L l L l L l

L l L l L l L l L l L l L l

L l L l L l L l L l L l L l

L l

L l



[em]
Mm



milk
[milk] 牛奶

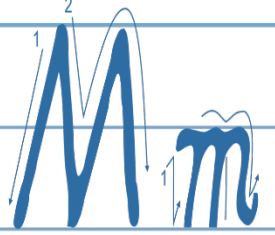

Mm Mm Mm Mm Mm Mm

Mm Mm Mm Mm Mm Mm

Mm Mm Mm Mm Mm Mm

Mm Mm Mm Mm Mm Mm

Mm

Mm

以上内容仅为本文档的试下载部分，为可阅读页数的一半内容。如要下载或阅读全文，请访问：<https://d.book118.com/266045114010010221>