

摄像机机构图的类型教学课件



A traditional Chinese ink wash painting of a landscape. The scene features misty, layered mountains in shades of green and blue, a calm lake in the foreground, and a large, bright red sun in the upper left corner. Several birds are depicted in flight across the sky. The overall style is soft and atmospheric, typical of classical Chinese art.

目录

- 引言
- 摄像机构图的基本类型
- 摄像机构图的应用场景
- 摄像机构图的绘制技巧
- 案例分析与实践
- 总结与展望



01

引言



目的和背景

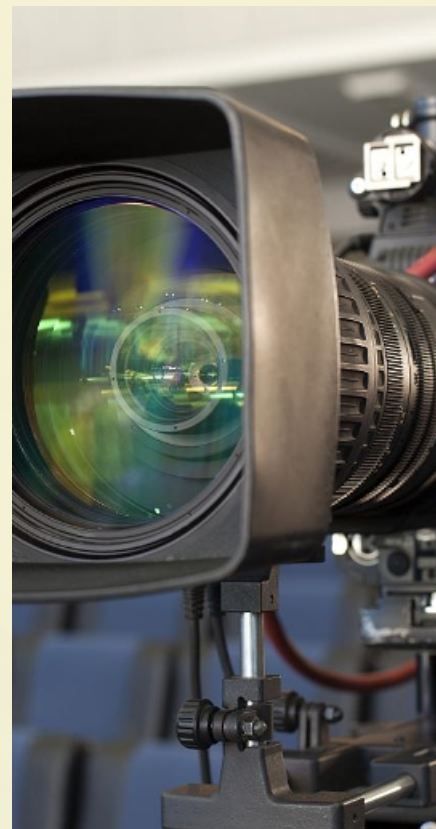
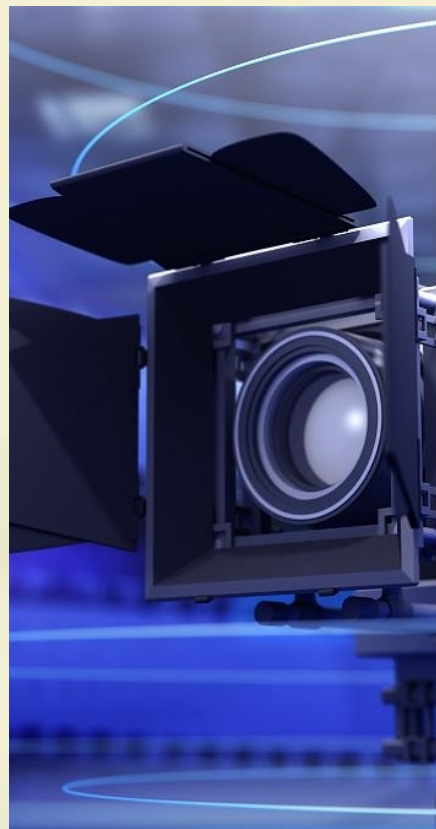

01

介绍摄像机构图在影视制作中的重要性，以及其在故事叙述、视觉效果和观众体验方面的作用。



02

分析当前市场对摄像机构图的需求和趋势，以及教学课件的必要性和目标受众。



课程简介



简要介绍本教学课件的内容和结构，包括摄像机构图的类型、应用场景、技巧和案例分析等。



强调本课件的教学目标和教学方法，如理论与实践相结合，案例分析和互动讨论等。

Lorem ipsum dolor sit amet, consectetur adipiscing elit. Aenean commodo ligula eget dolor. Aenean massa. Cum sociis natoque penatibus et magnis dis parturient montes, nascetur ridiculus mus. Donec quam felis, ultricies nec, pellentesque eu, pretium quis, sem. Nulla consequat massa quis enim. Donec pede justo, fringilla vel, aliquet nec, vulputate



Lorem ipsum dolor sit amet, consectetur adipiscing elit. Aenean commodo ligula eget dolor. Aenean massa. Cum sociis natoque penatibus et magnis dis parturient montes, nascetur ridiculus mus. Donec quam felis, ultricies nec, pellentesque eu, pretium quis, sem. Nulla consequat massa quis enim. Donec pede justo, fringilla vel, aliquet nec, vulputate



Lorem ipsum dolor sit amet, consectetur adipiscing elit. Aenean commodo ligula eget dolor. Aenean massa. Cum sociis natoque penatibus et magnis dis parturient montes, nascetur ridiculus mus. Donec quam felis, ultricies nec, pellentesque eu, pretium quis, sem. Nulla consequat massa quis enim. Donec pede justo, fringilla vel, aliquet nec, vulputate



The background is a traditional Chinese landscape painting. It features a large, vibrant red sun in the center, partially obscured by the text. The landscape consists of layered, misty mountains in shades of green and blue, with a body of water in the foreground. Several birds are depicted in flight, including a large white crane with black wings and a red beak in the upper left, and several smaller birds scattered across the sky.

02

摄像机构图的基本类型



正交视图

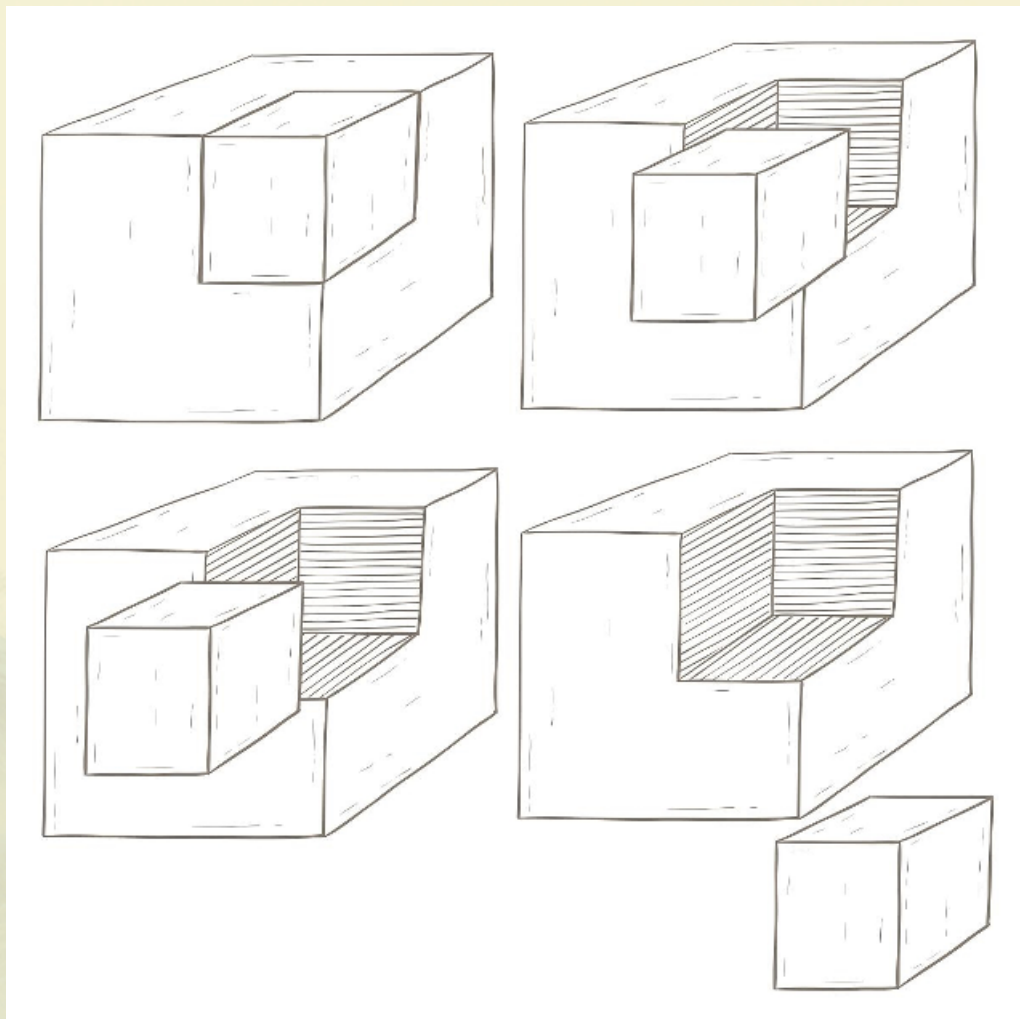

正交视图也称为平行视图，它是一种将物体投影到一个平面上，并保持物体的所有平行线都与投影平面平行的视图。在正交视图中，物体的长度和宽度被准确表示，但高度可能会有所变形。

正交视图包括顶视图、前视图、左视图和右视图。在顶视图中，物体被从顶部投影到平面；在左视图或右视图中，物体被从左侧或右侧投影到平面；在前视图中，物体被从前方投影到平面。



轴测视图



轴测视图是一种将物体围绕一个轴旋转并投影到平面上的视图。在轴测视图中，物体的长度、宽度和高度都得到了准确的表示，但透视效果较差。

轴测视图包括正轴测视图和斜轴测视图。在正轴测视图中，物体被围绕垂直轴旋转并投影到平面；在斜轴测视图中，物体被围绕倾斜轴旋转并投影到平面。

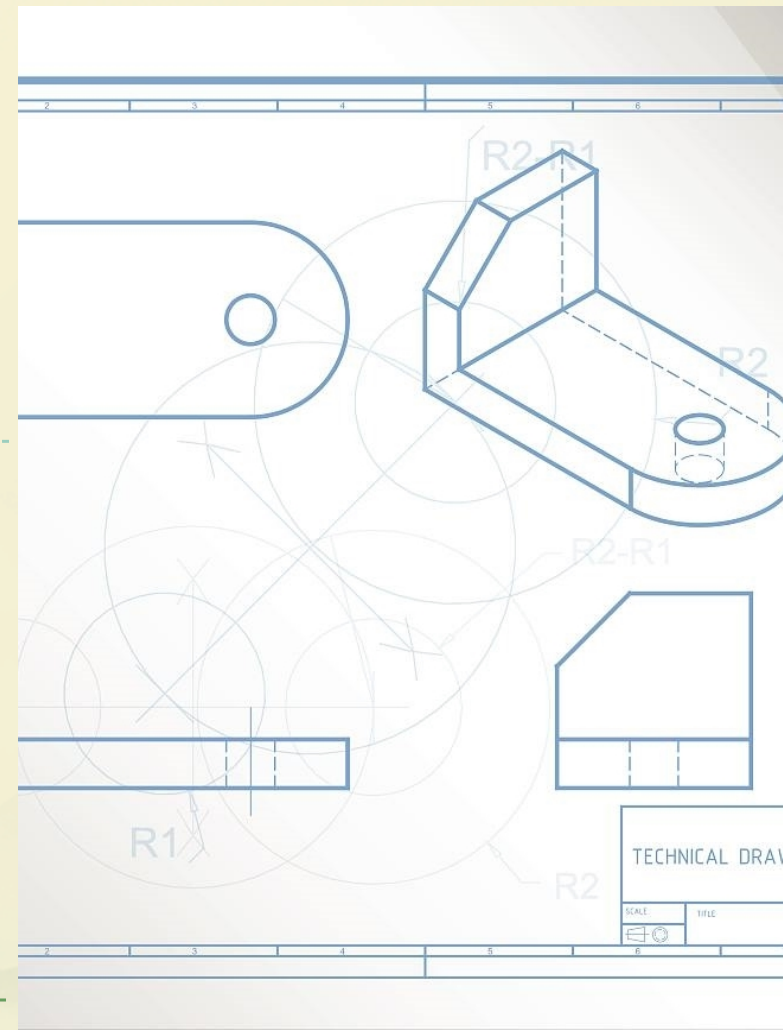



透视图

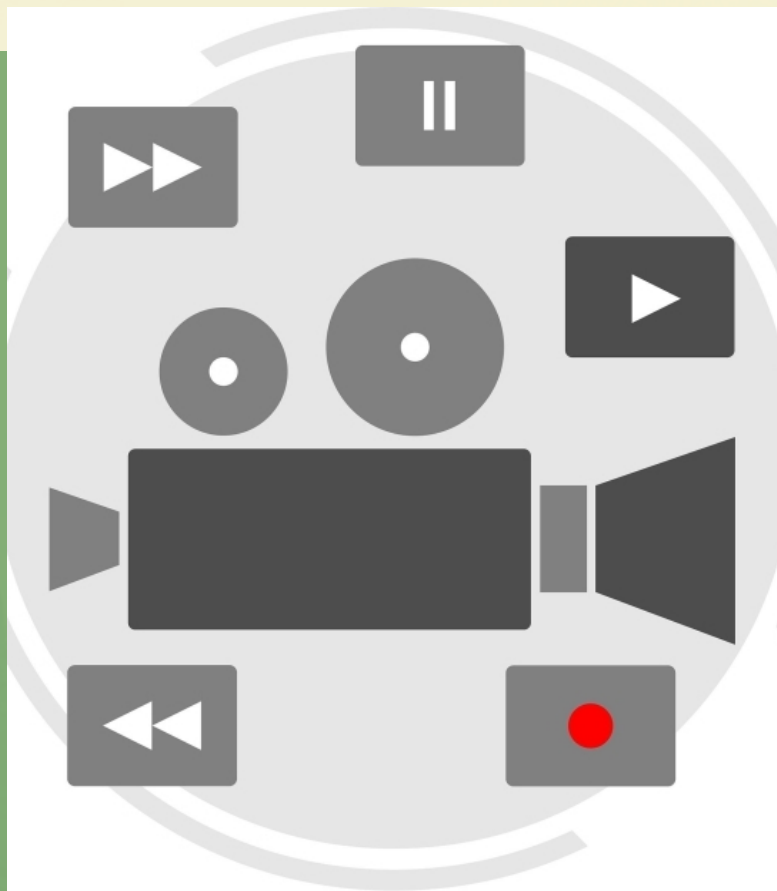

VIDEO

透视图是一种通过透视投影将物体表示在平面上的视图。在透视图，物体的长度和宽度可能会变形，但高度得到了准确的表示。

透视图通常用于表示三维空间中的物体，以强调物体的深度和立体感。在透视图中有许多种不同的透视类型，如一点透视、两点透视和三点透视等。





鸟瞰图



鸟瞰图是一种从高处俯视物体的视图，通常用于表示城市、建筑物或景观等大型场景。在鸟瞰图中，物体的长度和宽度得到了准确的表示，但高度可能会被压缩。

鸟瞰图通常用于规划、设计或展示目的，以便更好地理解场景的整体布局 and 关系。



03

摄像机构图的应用场景





建筑领域

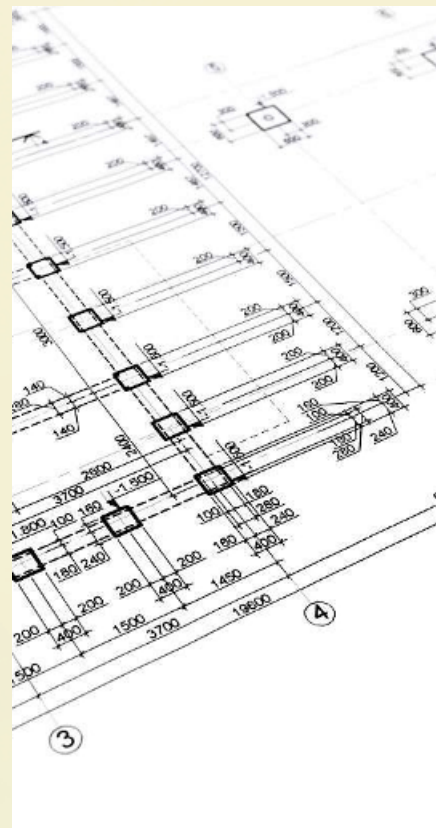
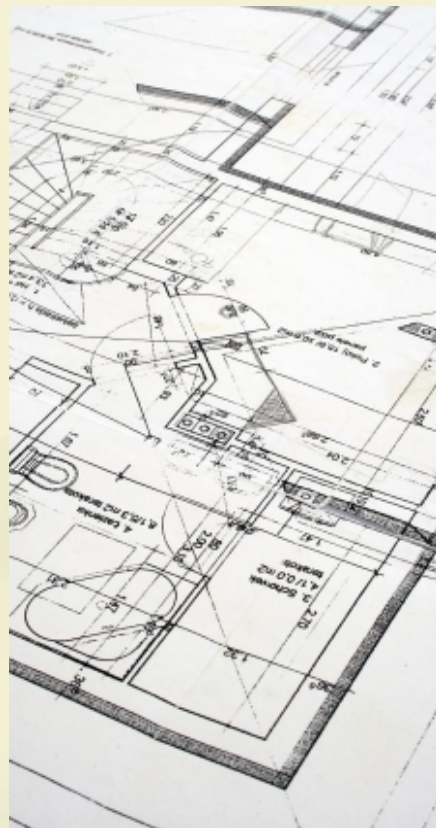

建筑图纸

摄像机构图常用于建筑领域，用于绘制建筑图纸，展示建筑物的外观、结构和布局。



城市规划

通过摄像机构图，城市规划师可以更好地展示城市规划方案，让客户和决策者更直观地了解规划效果。



产品渲染

工业设计师使用摄像机构图来渲染产品效果图，展示产品的外观和细节。

设计展示

工业设计师通过摄像机构图来展示设计成果，以便客户和合作伙伴更好地理解设计方案。



以上内容仅为本文档的试下载部分，为可阅读页数的一半内容。如要下载或阅读全文，请访问：
<https://d.book118.com/657101056035006060>